

Alligator® Light-Duty Belt Splicing Training Manual

**Alligator®**



FLEXLOK

LIGHT-DUTY BELT FASTENER SYSTEMS



Table of Contents

●	●	Proper Belt End Preparation	3
●	●	Alligator® Ready Set™ Staple Belt Fasteners	
●	●	Overview.....	4
●	●	Installation Tools	5
●	●	Installation Accessories	6
●	●	Identifying a Properly Installed Alligator Ready Set Splice	7
●	●	Troubleshooting	8-9
●	●	Tips	9
●	●	Alligator® Lacing	
●	●	Overview.....	10
●	●	Identifying a Properly Installed Alligator Lacing Splice	11
●	●	Troubleshooting	11
●	●	Alligator® Rivet Baler Fasteners	
●	●	Overview.....	12
●	●	Identifying a Properly Installed Alligator Rivet Splice	13
●	●	Troubleshooting	13
●	●	Tips	13
●	●	Alligator® Non-Metallic Splicing	
●	●	Overview.....	14
●	●	Identifying a Properly Installed Alligator Plastic Rivet Splice	14
●	●	Troubleshooting	15
●	●	Tips	15

Proper Belt End Preparation

Importance of a Square Cut

To prevent mistracking and extend splice life, it is critical to obtain a square cut off from the centerline of the belt. To achieve this, follow these simple steps:

1. Prior to any work on your conveyors, make certain that the power has been turned off and the belt is "locked out".
2. Mark the actual center points in belt width at intervals of 3 to 5 feet (900 to 1500mm), for a distance of 15 to 20 feet (4.5 to 6 M) back from the intended splice area (Fig. A).
3. Using either a steel rule or a chalk line, mark the average center line through the points measured in Step 2 (Fig. B).
4. Using a square, draw a line perpendicular to the average center line across the belt width (Fig. B).
5. Using the Clipper® 845LD Cutter, cut the belt on the line drawn in Step 4.

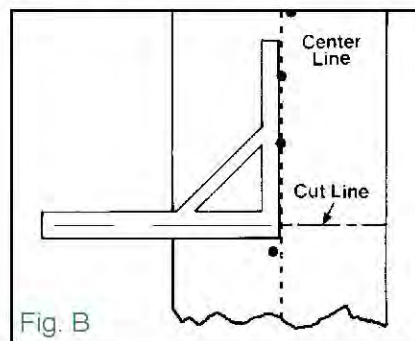
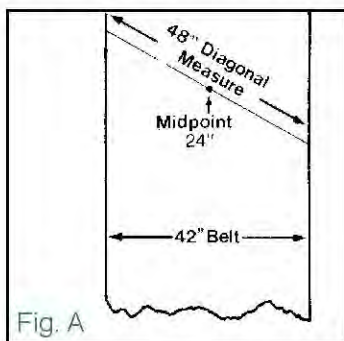

Skive Impression Cover Before Fastener Installation

It is important to skive off the impression cover of a belt in the area where fasteners will be applied. This allows the proper size fastener to be selected and for proper penetration/clinch. Two tools are available to assist in this process:

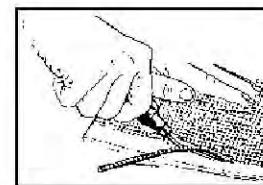

Rough Top Belt Skiver

This simple-to-use, hand-held tool skives off the impression cover when pushed along the belt cover.



RB-1 Belt Grinder

This air-drill attachable tool is made with carbide to cut the impression cover off the belt. Most standard grinders burn the impression cover off, which heats and damages the belt carcass, resulting in shorter splice life.





Alligator® Staple Overview

Advantages of Alligator® Ready Set™ Staple Fastening System:

- High strength splice
- Abrasion resistant splice
- Inexpensive, portable installation tool
- Easy installation procedures
- Easy to mesh lacing and insert pin



Two Styles of Alligator Staple Fasteners:

Ready Set™: Available in Steel, 430 Stainless Steel and 316 Stainless Steel. Ready Set Staple Fasteners feature a one-piece fastener strip with pre-inserted staples, reducing installation time by eliminating the need to handle and load individual staples. The result is a strong splice that resists impact damage, as well as a smooth, unrippled joint to simplify hinge pin insertion.



Conventional Staple Fasteners: Available in abrasion resistant MegAlloy®, providing several times the service life of steel. Staples are separate from the fastener plates. Green guide blocks (ST4-5) must be installed on the installation tool and users can insert staples using the C150 staple dispenser.



ALLIGATOR® READY SET™ STAPLE								
Fastener Size	Operating Tension Range		Belt Thickness Range		Minimum Pulley Diameter		Approximate Hinge Pin Diameter	
	P.I.W.	kN/m	in.	mm	in.	mm	in. (nylon-steel)	mm (nylon-steel)
RS62	100	17	1/16-1/8	1.5-3.2	2	50	nylon .080, steel .080	nylon 2.0, steel 2.0
RS125	160	28	1/8-3/16	3.2-4.8	3	75	nylon .141, steel .141	nylon 3.6, steel 3.6
RS187	200	35	3/16-1/4	4.8-6.4	4	100	nylon .203, steel .187	nylon 5.2, steel 4.7

METAL SELECTION CHART	
Metal Type	Application
Steel	Standard fastener material suitable for most applications. Plated for rust and corrosion resistance.
316 Stainless Steel	Extra resistance to abrasion, magnetic attraction, and corrosion from acids and chemicals. Excellent for high sanitary requirements.
430 Magnetic Stainless Steel	For use with magnetic separators. Provides resistance to wear and abrasion. Plate, staples, and hinge pins are all constructed from magnetic stainless steel.
MegAlloy®	Superior resistance to wear and abrasion, providing several times the service life of steel. Not recommended where subject to impact or corrosion. Not available in the Ready Set configuration.



Alligator® Staple Installation Tools

Alligator® RSC187 Installation Tool

The RSC187 Installation Tool securely holds fasteners in proper alignment and guides staples as they are driven. Installs two staples simultaneously for fast and simple splicing. Also provides a solid anvil surface for initial staple clinching.

The RSC187 comes complete with a driver and guide blocks for all three fastener sizes. Also available in sizes to match a variety of belt widths; wider tools are available for production lacing and fabrication shop requirements.



Alligator® Staple Tool Kit

Everything needed to install Alligator® Ready Set™ Fastener Systems, in a lightweight, easy-to-carry toolbox. Includes a RSC187 Installation Tool, ST3-9 Staple Driver, SR-28 Staple Set Plate, RTBS Rough Top Belt Skiver, BN-1 belt nippers, and 1-lb. hammer.



New! Quad Staple Driver™

Using a 2-lb. hammer, the Quad Staple Driver simultaneously drives four staples, cutting installation time in half.



Alligator® Staple Installation Accessories

Staple Setting Plate (ST-28)

Final set of the staples and proper compression of the fastener plate are necessary for long splice life. The heat-treated steel setting plate provides the required hardened surface to achieve a properly installed splice. The ST-28 also features countersunk bolt holes for mounting onto a work surface.



Alligator® Hinge Pin Cutter (APC-1)

Cuts bulk hinge pin cable quickly and easily. Provides a clean cut with no frayed ends.



Hinge Pin Retaining Washers

Retaining washers prevent migration of nylon-covered cable hinge pins. Check hinge pins frequently during the first few hours of operation to determine whether migration is a problem in your application; use retaining washers if necessary.



Hinge Pin Bender (PB1)

For use with steel spring wire pin. Bends hinge pin end to prevent pin migration.



Rough-Top Belt Skiver (RTBS)

Durable, hand-operated tool for quick and clean removal of rough top from light- and medium-duty conveyor belting.



Belt Nippers (BN-1)

A simple, hand-held tool used to notch/chamfer belt edges and to remove individual fastener plates from belt.



Identifying a Properly Installed Alligator® Ready Set™ Splice



ALLIGATOR® STAPLE

1. Staples should be completely driven through and properly set into pockets on bottom side of fastener plates.

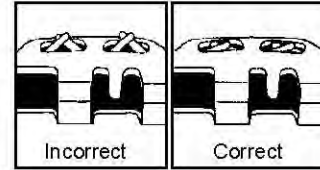

2. There should be a slight puckering of the belt at the front edge of the top plate. On belts with very hard top covers, or no top cover, this may not always be possible.

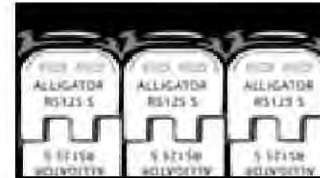

3. Fastener plates should be firmly compressed onto belt and you should not be able to catch your fingernail under front edge of fastener plate.

4. Loops have not been crushed. Hinge pin insertion is easy.



5. Belt is flush against fastener belt stops across width of belt; fasteners are parallel with belt edge.

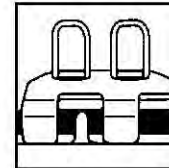

6. Corners on trailing end of belt have been notched/chamfered.

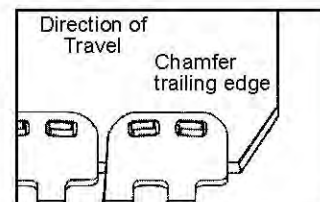

7. Pin Retaining Washers, if used, are properly crimped.

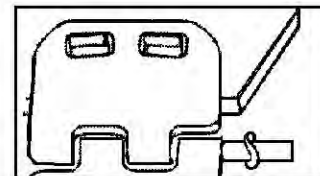

Troubleshooting

The Fastener Plates Are Loose:

Fasteners were not fully set.

- Fasteners should be firmly set, creating a slight puckering of belt around front edge of top plate. This may not be possible on hard belts or belts with little top cover.
- You should not be able to catch a fingernail under plates.
- Belt is either too thin or too thick for size of Alligator® Staple fastener selected. Confirm proper size has been selected.
- Rough top belt was either not skived or the belt was skived too thin for the size of Alligator Staple fastener being used.



'Final Set' procedure was performed on a surface other than a hardened steel plate.

- A hardened steel plate, such as the Flexco ST-28 setting plate, should be used. Surfaces such as soft steel or wood will not allow staples to be fully set and/or can cause staple leg to deflect out of the pocket.

'Final Set' procedure was performed from bottom side of the fastener, causing staples to back out or to buckle inside of the belt.

- Final setting of staples should always be performed from top side of fastener on a hardened steel plate.



The Staples Misfire During Installation:

Either too heavy a hammer or the wrong type of hammer was used.

- A 1-lb. hammer is recommended with the standard Staple Driver.
- A 2-lb. hammer is recommended with the Quad Staple Driver™.
- A dead blow, soft steel or rubber hammer should not be used.

Initial hit with the hammer was too hard.

- Starting with a moderate blow, hit driver with three to five consecutive blows, each blow harder than the previous one.

Anvils in the Alligator® RSC187 Tool are worn or broken.

- Inspect for deep/worn pockets and chipped/worn walls in angled areas of the anvils.
- Check alignment of guide block posts.

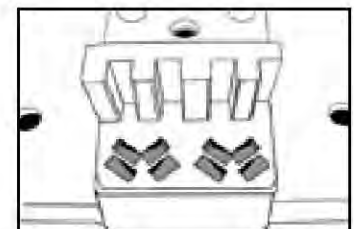

A mild steel plate was used for 'Final Set' procedure.

- Use only a hardened steel plate, such as the Flexco ST-28, when performing the 'Final Set' procedure of the Ready Set fasteners.



Troubleshooting (cont.)

The Fasteners Are Not Flush and Parallel With Belt Edge:

Belt was not installed flush against the Ready Set fastener belt stops.

Fasteners were installed from 'left to right' or 'right to left'.

- First install the center two fasteners and then install fasteners on outside edges. Finish by installing the remaining fasteners.

Cam levers were not properly engaged or are worn.

- Tighten cam lever by turning it clockwise until a snug lock is achieved.
- Replace cam levers.

Spring-loaded belt nails located in top block of the Alligator RSC187 are stuck or are missing. Replace top block as needed.

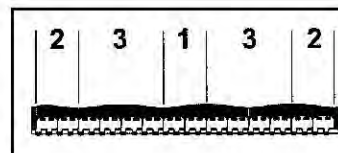
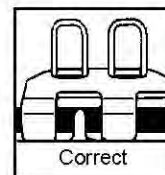

Tips

- Procedure for removing an Alligator® Staple fastener from a laced belt end

In the event of a misfired staple there may be the need to remove a single Staple fastener plate from the laced belt end. To do so:

1. Using the Flexco Belt Nippers, cut the back side of both loops on the fastener to be removed.
2. Use the Belt Nippers pull the top plate off. This will take some effort because the staples will need to be pulled straight.
3. Break the bottom plate free from the adjoining fasteners by flexing the belt back and forth at one of the two scores on the bottom plate.
4. With one score broken, use the Belt Nippers to flex the loose plate at the remaining score to break the bottom plate free.
5. Remove a single Staple fastener plate from a new fastener strip by flexing an end fastener at the score until it breaks off.
6. Install the single fastener plate using the RSC187 installation tool and a standard two-pronged driver.

- Alligator RSC187 Installation Tools that are 12" (300mm) or wider are designed with a Belt Release Bar. Use a light hammer blow on the ends of the Belt Release Bar to disengage the Ready Set fasteners from the tool.
- If you are not sure of the direction of belt travel, notch/ chamfer all four corners.

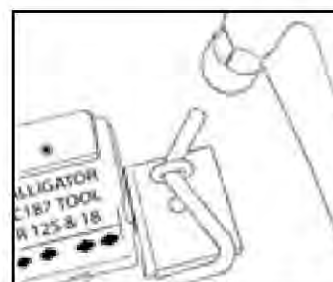



Alligator® Lacing Overview

Advantages of the Alligator® Lacing System:

- Low profile
- Hammer applied; Does not require special installation tools
- Can be installed in the Clipper® Roller Lacer® and Pro Lacers with appropriate combs, if so desired.

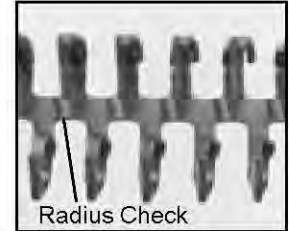

Two Styles of Alligator Lacing:

Conveyor Belt Lacing: Features a “radius check” reference point to aid in trimming strips for narrower belt widths.

Transmission Lacing: For flat power transmission belts up to 12" (300mm) wide. Lacing is scored, so it can break away to custom-fit belts narrower than the packaged fastener length.

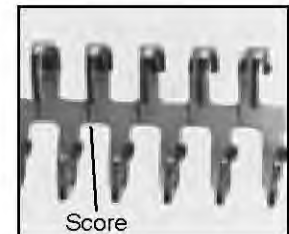

ALLIGATOR® LACING SELECTION CHART

Lacing Size	For Belts with Mechanical Fastener Ratings Up To:		Belt Thickness Range		Minimum Pulley Diameter		Corrugated Hinge Pin Diameter	
	P.I.W.	kN/m	in.	mm	in.	mm	in.	mm
00	25	4.3	up thru 1/16	up thru 1.6	1	25	3/64	1.2
1	45	7.8	1/16–3/32	1.6–2.4	1-1/2	38	1/16	1.6
7	50	8.7	3/32–9/64	2.4–3.6	2	51	1/16	1.6
15	65	11.4	1/8–5/32	3.2–4.0	2-1/2	64	3/32	2.4
20	95	16.6	5/32–3/16	4.0–4.8	3	76	7/64	2.8
25	100	17.5	3/16–7/32	4.8–5.6	4	102	1/8	3.2
27	100	17.5	7/32–9/32	5.6–7.1	5	127	1/8	3.2
35	150	26	9/32–5/16	7.1–7.9	7	178	9/64	3.6
45	165	28	5/16–3/8	7.9–9.5	9	229	3/16	4.8
55	175	30	3/8–7/16	9.5–11.1	12	305	13/64	5.2
65	200	35	7/16–1/2	11.1–12.7	14	356	13/64	5.2

METAL SELECTION CHART

Metal Type	Application
Steel	Suitable for most applications. Sizes 00, 1, and 7 are plated for rust and corrosion resistance.
316 Stainless Steel	Provides extra resistance to abrasion, magnetic attraction, and corrosion from acids and chemicals. Also excellent for high sanitary requirements.

PIN SELECTION CHART

Metal Type	Application
Corrugated Steel or Stainless Steel	Rigid pin with corrugation to prevent pin from migrating out of the splice.
Nylon Covered Steel or Stainless Cable	Available in coil lengths. Ideal for applications with crowned pulleys or with troughing idlers.
Steel or Stainless Steel Rocker Pins	Used with Transmission Lacing. Two-piece design creates a rocking action to reduce wear and friction on the fastener loops. Furnished with Transmission Belt Lacing sizes 15 - 65. Corrugated pins are furnished with Transmission Belt Lacing sizes 00, 1 and 7.

Identifying a Properly Installed Alligator® Lacing Splice



1. Lacing should be flush with belt surface.
2. Points should slightly penetrate opposite side of belt.
3. Loops of lacing should not be crushed and will easily accept the hinge pin.

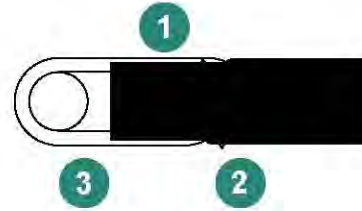

Troubleshooting

Lacing Teeth Do Not Fully Penetrate Belt and Clinch Over

Be sure to use a soft piece of wood under the fastener when first applying lacing. This allows the teeth to fully penetrate the belt.

Ensure the following installation procedures have been followed. *NOTE:* Steps 1-4 are performed using the soft piece of wood as a backing plate.

1. From **top side** of belt, install end two teeth on both belt edges halfway in.
2. Flip belt over and install fastener teeth on bottom side of belt halfway in across **entire** splice width.
3. Flip belt back over and finish installing remaining teeth on top side of belt.
4. Repeat on bottom side of belt.
5. Use a hardened steel plate and final set the lacing.

Hinge Pin is Difficult to Insert

Be sure to use gauge pin and clips when applying Alligator Lacing. This will ensure a uniform loop across the entire width.

Loops may have been crushed with direct hammer blows. Use caution when installing fasteners and do not hit the loops.

Failure to follow proper lacing installation sequence as described above in Steps 1-5 can cause points on non-bar side of lacing to wander and not penetrate correctly. This can cause a distortion in the loop area, making pin insertion very difficult.

Alligator® Rivet Baler Fastener Overview

Advantages of Alligator® Rivet Fastener System:

- High strength splice
- Superior abrasion resistance
- Portable tool allows for on-site installation
- Easy installation
- Fasteners are available in pre-cut common baler belt widths

ALLIGATOR® RIVET SPECIFICATION CHART

Operating Tension Range		Belt Thickness Range		Pulley Diameter		Hinge Pin Diameter	
P.I.W.	kN/m	in.	mm	in.	mm	in.	mm
300	52	1/8 – 7/32	3.2 – 5.6	3-1/2	88	.140	3.6

Application Tools and Accessories:

Hand Applicator Tool: Available in 7" and 14" widths. Portable for on-site installation. Tool has built-in belt stops to prevent belt from entering fastener loop area. Belt clamp secures belt during installation process.

Multiple Rivet Installation Tool: Available in 7" and 14" widths. This tool is comprised of a Hand Applicator Tool plus the Multiple Rivet Installation block. Users can install rivets with either a hammer and hand-punch, or with an air hammer and pneumatic punch. Simplifies installation procedure and reduces fatigue.



Identifying a Properly Installed Alligator® Rivet Splice

1. Fasteners should be fully clinched and you should not be able to catch your fingernail under the front edge of the fastener plates. *NOTE:* Using the Alligator Rivet Application Gauge can help to insure fasteners are properly set. Finished splice should fit into the "Maximum Finished Rivet Height" slot in the gauge.
2. There should be a slight puckering of the belt at the front edge of the top plates.

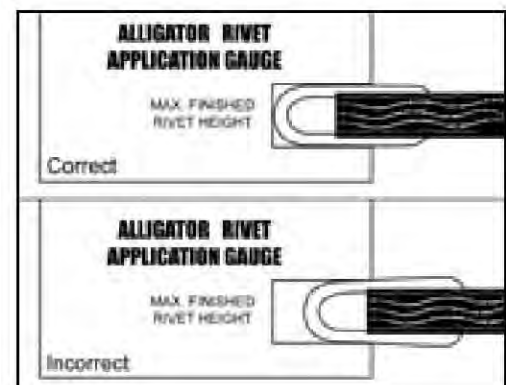

Identifying a Properly Installed Alligator[®] Rivet Splice



(continued)

3. Rivets should be fully set and curled on bottom side of splice.
4. Loop area of fastener is oval in shape and easily accepts the hinge pin.
5. Fasteners are inset 1/4" (6.4mm) from each belt edge.
6. Corners of trailing end of belt have been notched/chamfered.

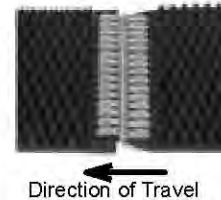
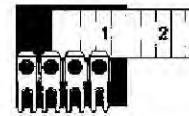
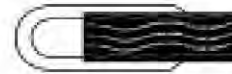
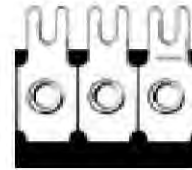

Troubleshooting

Fasteners Are Loose

Fasteners were not fully set when applied.

- You may be able to reinsert splice into the ART tool and reset with a hammer. If you attempt to reinsert splice into the ART tool, **make sure you have left Pilot Nails in tool so rivets properly curl.**

Belt was not skived to remove rough top or diamond top impression cover.

Belt was skived too thin for Alligator Rivet fasteners.

- Use Alligator Rivet Application Gauge to double-check acceptable skived belt thickness.

Belt Edges Do Not Line Up

Align belt edges with appropriate scribe marks on ART tool based on your belt width.

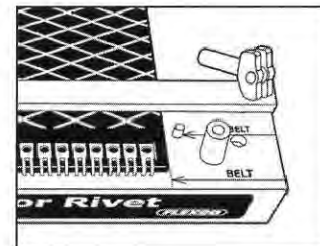

Tips

- You may find it easier to join splices together by laying one laced belt end over the other belt and pressing them together versus trying to mesh them end to end.
- Hitting center of belt directly behind ART tool helps to release Pilot Nails, making it easier to remove laced belt from the tool.

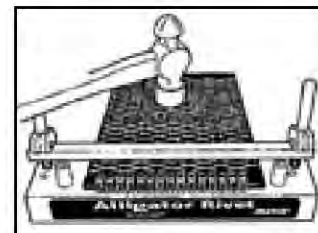



Alligator® Non-Metallic Splicing Overview

Advantages of Alligator® Non-Metallic Splices:

- Non-metallic
- Non-magnetic
- Non-sparking
- Quiet
- Hinged splice; quicker installation on conveyor system.
- Compatible with X ray machines, metal detectors, and food applications

Two styles of Alligator Non-Metallic Fasteners:

Alligator® Spiral Lace: Low-profile, non-metallic splice that is compatible with pulleys as small as 1/2" (13mm) and for applications up to 50 PIW (8.7 kN/m). Splice is fabricated into belt through a ply separation, ply step, or finger splice vulcanization processes. Available in black or white polyester, or in PEEK for high heat applications.

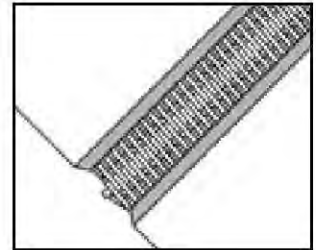

Alligator® Plastic Rivet: One-piece, cover-mounted fastener features an integrated design with rivets molded into the fastener top plate. Fastener edge is beveled to ensure smooth transition and easy cleaning. Fasteners are installed with the Alligator Spin Set Tool™. This portable tool allows for simple installation anywhere in your facility.



Identifying a Properly Installed Alligator® Plastic Rivet Splice

1. Fastener plates are flush against belt and you cannot catch a fingernail under the front edge of the fastener plate.
2. Rivets have been fully compressed and melted into a nice dome shape.
3. Corners have been notched/chamfered on trailing end of belt.

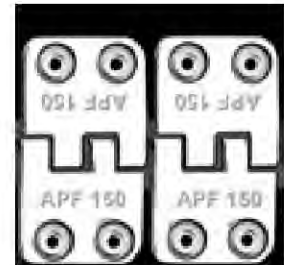
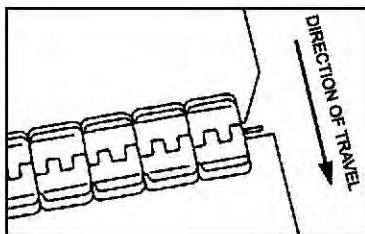

Troubleshooting

Fasteners Are Loose

Plastic rivets may not have been fully compressed during installation.

Alligator Plastic Rivet Lube was not used during installation of the fasteners.

- Using lube allows plastic rivets to melt at the proper speed and helps to control heat generated during the installation/melting process.

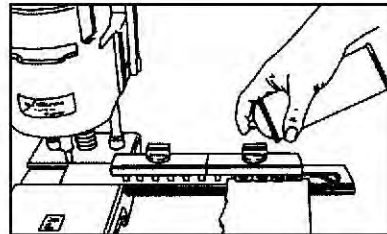

The Rivets Loosen or Break When In Service

Rivets may have been overheated during installation process.

- Be sure to use Alligator Plastic Rivet Lube when compressing/melting plastic rivets to avoid overheating plastic and making it brittle.

Conveyor tension exceeds recommended tension for this fastener.

Tips

- Take care when using the belt punch and template to avoid embedding steel shavings from template into the belt.
- Drill straight down into the template and do not lean punch/bit against edge of guide holes in template.



Eng-Thira Co., Ltd.

1721/5 Chan Road

Kwang Thungmahamek, Khet Sathorn

Bangkok 10120, Thailand

Telephone: 081-816-4445, 086-308-8183

WWW.ENG-THIRA.COM

